

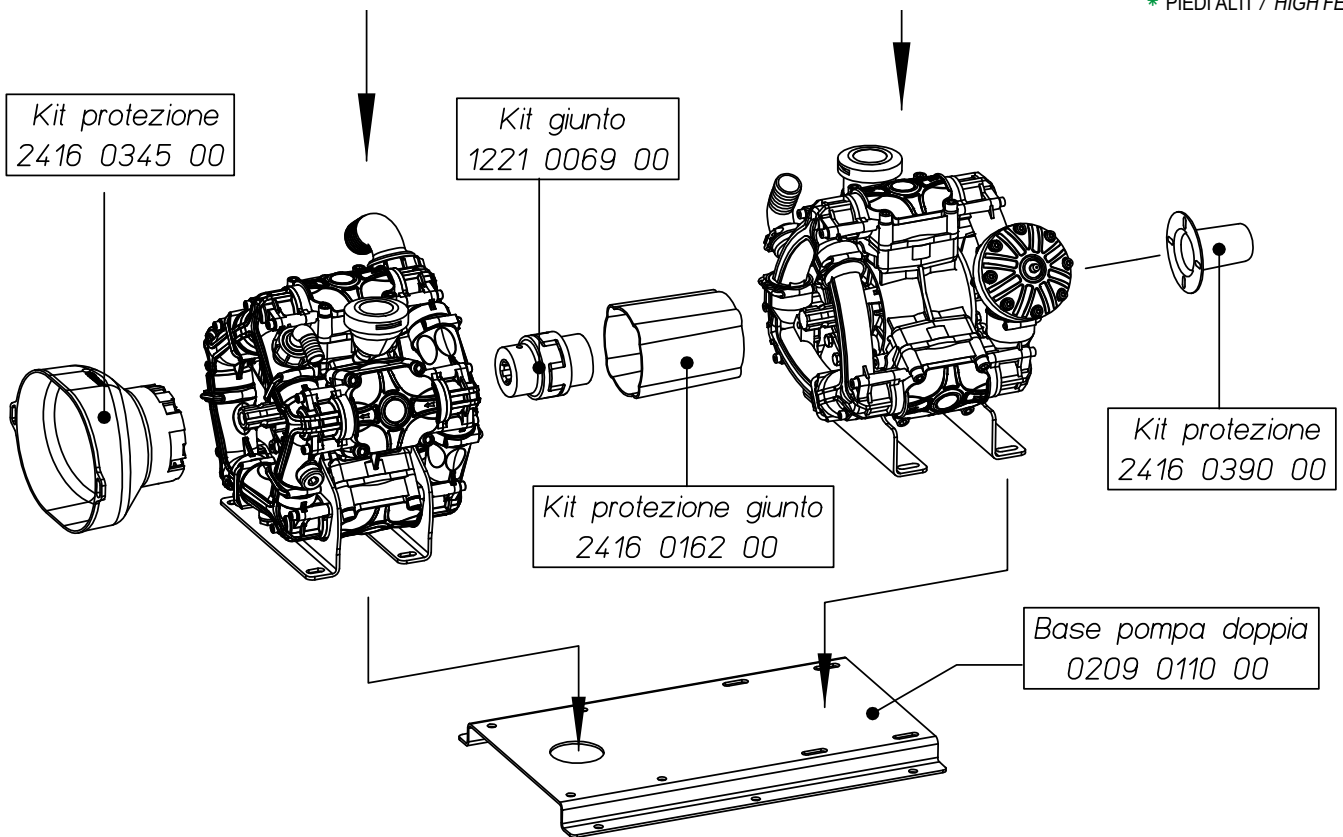







BPS TANDEM	ESEMPI DI CONFIGURAZIONI POSSIBILI › STANDARD VERSIONS	
	A PUMP / POMPA	B PUMP / POMPA
	BPS 300 AEP 1" 3/8 M-M DS 6150 0004	BPS 300 AEP 1" 3/8 M-M DS 6150 0004 BPS 260 AEP 1" 3/8 M-M DS 6147 0002 BPS 200 AEP 1" 3/8 M-M DS * 6144 0011 BPS 160 AEP 1" 3/8 M-M DS * 6154 0011
	BPS 260 AEP 1" 3/8 M-M DS 6147 0002	BPS 260 AEP 1" 3/8 M-M DS 6147 0002 BPS 200 AEP 1" 3/8 M-M DS * 6144 0011 BPS 160 AEP 1" 3/8 M-M DS * 6154 0011
	BPS 200 AEP 1" 3/8 M-M DS 6144 0002	BPS 200 AEP 1" 3/8 M-M DS 6144 0002

* PIEDI ALTI / HIGH FEET.



	PROTEZIONE ANTERIORE <i>Front guard</i>	2416 0345
	KIT GIUNTO ELASTICO <i>Elastic coupling kit</i>	1221 0069
	KIT PROTEZIONE GIUNTO <i>Protective coupling kit</i>	2416 0162
	BASE STANDARD, PER FISSARE LA BASE USARE BULLONI M12 <i>Standard base, use M12 bolts to fix the base</i>	0209 0110
	KIT PROTEZIONE FISSA LATO ASPIRAZIONE <i>Fixed protection suction side kit</i>	2416 0390